

M4N Series

DIN W48×H24mm Small Size Digital Panel Meter

■ Features

- Max. display: 1999
- Auto Zero function and Hold function
- 7-segment LED display
- Power supply: 5VDC, 12-24VDC

⚠ Please read "Safety Considerations" in the instruction manual before using.



■ Ordering Information

M	4	N	-	DV	-	0	1	
Item	Digit	Size		Measurement function (input)		Power supply	Measurement input	
				DV	DC Voltage			DC voltage input F.S.
				DA	DC Current			DC current input F.S.
				DI	DC4-20mA (scaling meter) ^{※1}			
				N	DIN W48×H24mm			
				4	1999 (3½-digit)			
				M	Meter			

※1: 1-5VDC measurement input is option.

■ Specifications

Model	M4N-DV-□□	M4N-DA-□□	M4N-DI-□□
Measurement input	DC voltage	DC current	DC4-20mA
Power supply	5VDC [※] , 12-24VDC [※]		
Allowable voltage range	90 to 110% of rated voltage		
Power consumption	2W		
Display method	7-segment LED display (red) (character height: 10mm)		
Max. display range	1999		
Display accuracy	F.S. ±0.2% rdg ±1-digit		
Sampling period	300ms		
A/D switching method	Dual integral method		
Response time	Approx. 2 sec (0 to 1999)		
Max. allowable input	150% of measurement input range		
Sampling time	2.5 times/sec		
Insulation resistance	Over 100MΩ (at 500VDC megger)		
Dielectric strength	2000VAC 50/60Hz for 1 min		
Noise immunity	±100V the square wave noise (pulse width: 1μs) by the noise simulator		
Vibration	Mechanical	0.75mm amplitude at frequency of 10 to 55Hz (for 1 min) in each X, Y, Z direction for 1 hour	
	Malfunction	0.5mm amplitude at frequency of 10 to 55Hz (for 1 min) in each X, Y, Z direction for 10 min	
Shock	Mechanical	300m/s ² (approx. 30G) in each X, Y, Z direction for 3 times	
	Malfunction	100m/s ² (approx. 10G) in each X, Y, Z direction for 3 times	
Environment	Ambient temperature	-10 to 50°C, storage: -20 to 60°C	
	Ambient humidity	35 to 85%RH, storage: 35 to 95%RH	
Unit weight	Approx. 44g		

※Environment resistance is rated at no freezing or condensation.

Compact Panel Meter

■ Dimensions

(unit: mm)

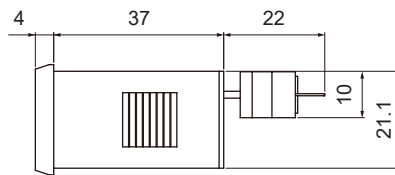
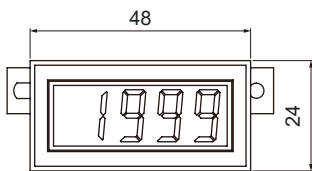
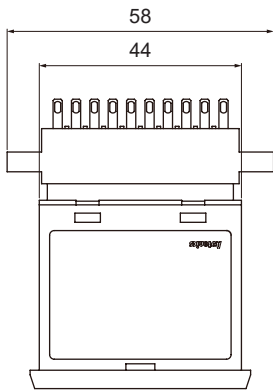

● Bracket

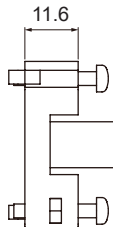
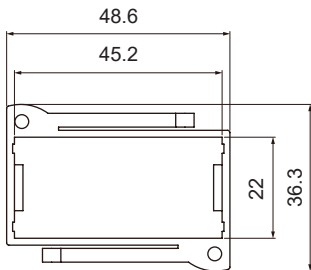
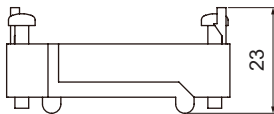

● Panel cut-out

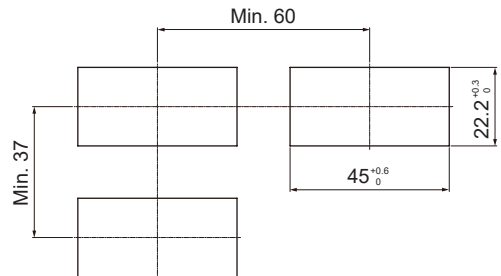

■ Mounting

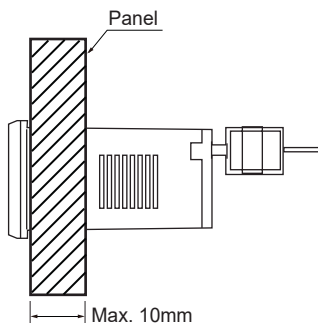

※Panel board thickness should be less than 10mm.

SENSORS
CONTROLLERS
MOTION DEVICES
SOFTWARE

(J) Temperature Controllers
(K) SSRs
(L) Power Controllers
(M) Counters
(N) Timers
(O) Digital Panel Meters
(P) Indicators
(Q) Converters
(R) Digital Display Units
(S) Sensor Controllers
(T) Switching Mode Power Supplies
(U) Recorders
(V) HMIs
(W) Panel PC
(X) Field Network Devices

M4N Series

Connections

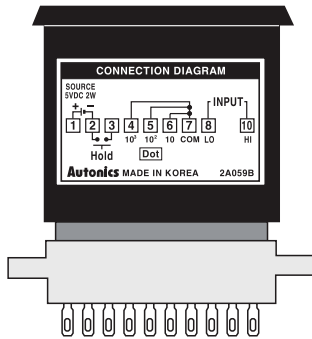

※Socket Pin no.: 1 2 3 4 5 6 7 8 9 10

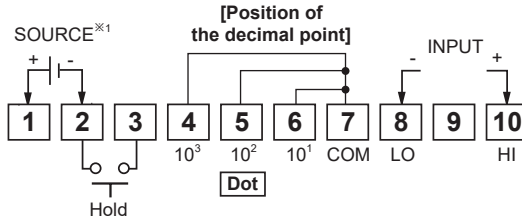

※1: 5VDC, 12-24VDC

※When changing the position of the decimal point, disconnect switching pattern point on PCB and change the decimal point in the external terminal socket. (Refer to 'Proper Usage'.)

※When "I" or "I" is flashes with a certain measurement input, disconnect power supply and then check the cables.

※Socket pin no. 9, NC terminal, is not connected at inside.

Connections of Applications

DC voltmeter connection

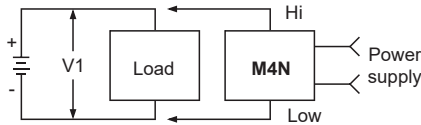

(Fig. 1) Measuring input (V1) is under 200VDC

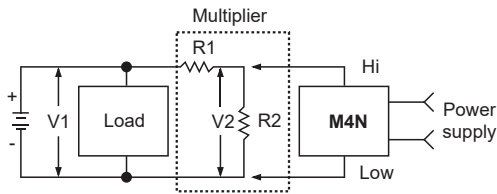

(Fig. 2) Measuring input (V1) is under 200VDC

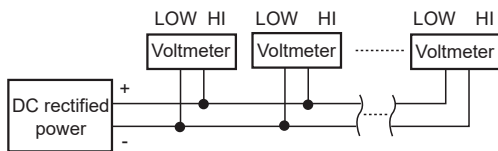

(Fig. 3) In case of using multiple voltmeter

※When the measuring voltage is over 200VDC, please select R1 and R2 in order to make V2 less than max. measuring voltage using multiplier.

$$V2 = \frac{R2}{R1+R2} \times V1 \quad R1 > R2$$

※It is available using several voltmeters with providing one DC power. However, the potential difference between - of measurement input and - of power may cause an error.

DC ammeter connection

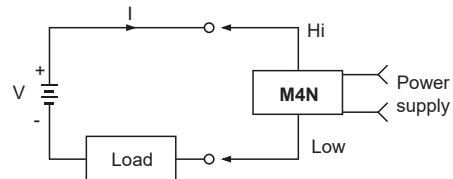

(Fig. 4) Measuring current is under DC200mA

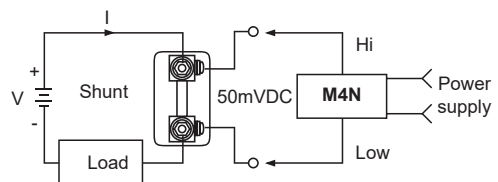

(Fig. 5) Measuring current is 50mVDC

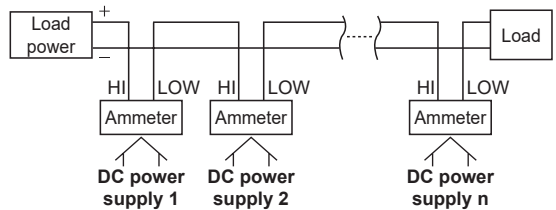

(Fig. 6) In case of using multiple ammeter

※When the current is higher than DC200mA, please use shunt.

※Second section of shunt is DC50mV.

※Ammeter cannot be used with above connection, please provide power separately.

Compact Panel Meter

⊙ Simultaneous connection of voltmeter and ammeter

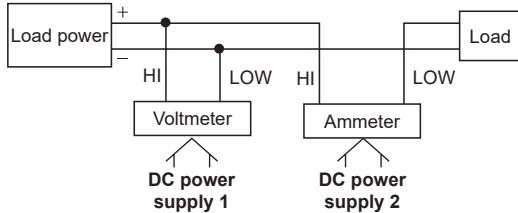

- ※When using voltmeter and ammeter simultaneously, connect the separated power supply each.
- ※(-) terminal of the power and (-) terminal of measurement input are shorted.
In case of using same power supply, measurement error or overcurrent may occur.

⊙ Scaling meter connection

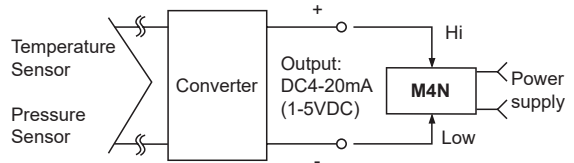

※1-5VDC output of converter is sold separately.

■ Proper Usage

⚠ Cautions during use

- Follow instructions in 'Cautions during use'. Otherwise, it may cause unexpected accidents.
- 5VAC, 12-24VDC power supply should be insulated and limited voltage/current or Class 2, SELV power supply device.
- Install a power switch or circuit breaker in the easily accessible place for supplying or disconnecting the power.
- Keep away from high voltage lines or power lines to prevent inductive noise.
In case installing power line and input signal line closely, use line filter or varistor at power line and shielded wire at input signal line.

Do not use near the equipment which generates strong magnetic force or high frequency noise.

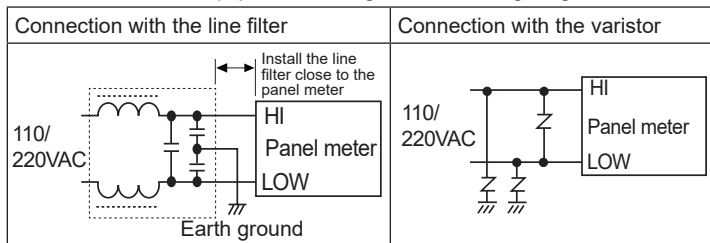

- This unit may be used in the following environments.

① Indoors (in the environment condition rated in 'Specifications')	② Altitude max. 2,000m
③ Pollution degree 2	④ Installation category II

⊙ Indicating method of unit

M4N is not indicated a unit on the product, therefore please indicate it in panel.

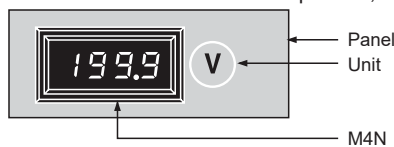

⊙ Display of decimal point

The displaying decimal point is set in the product by your order. (10^1 : DOT1, 10^2 : DOT2, 10^3 : DOT3)
When changing the position of the decimal point, disconnect switching pattern point on PCB and change the decimal point in the external terminal socket.

(If changing only at the external terminal socket not disconnecting switching pattern point on PCB, it displays both set points: one from PCB, one from the external terminal socket)

※DP□ pattern points on PCB are not related with the decimal point. Do not change the soldering.

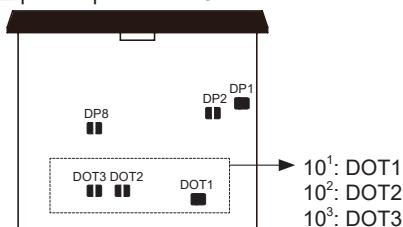

SENSORS
CONTROLLERS
MOTION DEVICES
SOFTWARE

(J) Temperature Controllers
(K) SSRs
(L) Power Controllers
(M) Counters
(N) Timers
(O) Digital Panel Meters
(P) Indicators
(Q) Converters
(R) Digital Display Units
(S) Sensor Controllers
(T) Switching Mode Power Supplies
(U) Recorders
(V) HMIs
(W) Panel PC
(X) Field Network Devices